

USK4.8 Outdoor Waterproof Type Fixed LED Display Unit



100% Front and 100% Rear



Energy Saving Design



Good Heat Dissipation



Smart Monitoring*



Die-casting Aluminum



IP69K Waterproof



EMC Class B for tile



Supports Curved Design

Cabinet Drawing

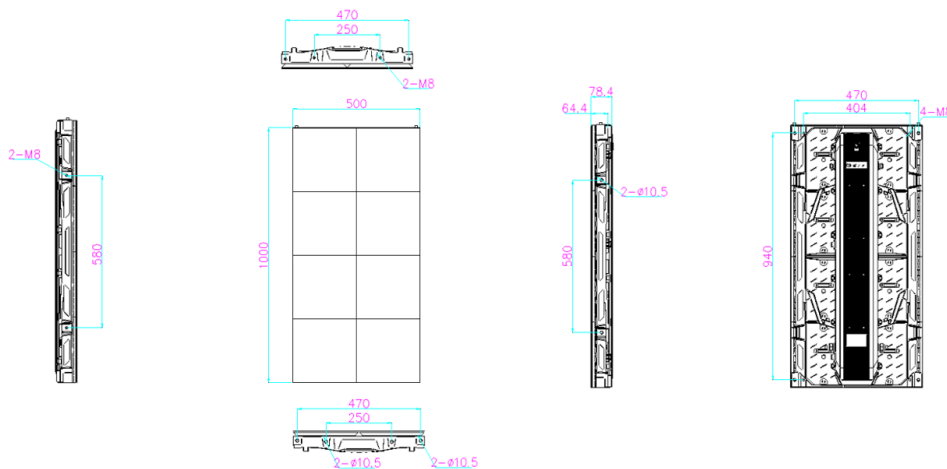

Figure 1 500*1000 Drawing of Cabinet

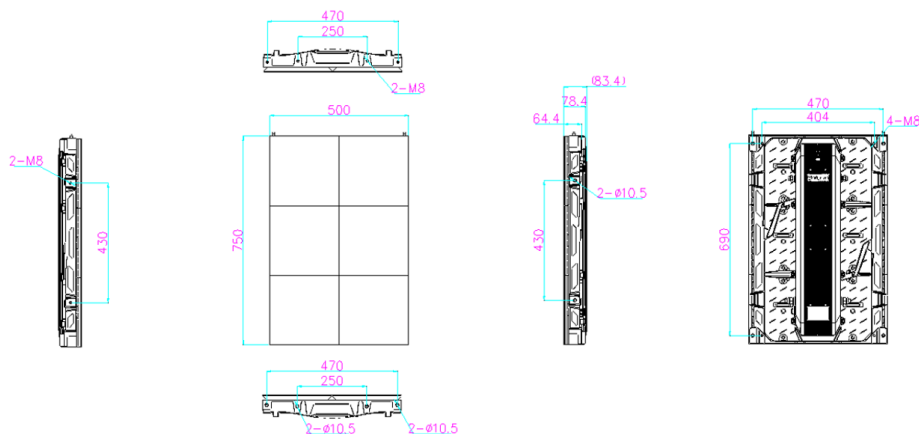

Figure 2 500*750 Drawing of Cabinet

Main Technical Specifications

Parameter	Value	
Pixel Pitch	4.8mm	
LED Type	3-in-1 SMD1921	
Brightness	6000cd/m ²	
Pixel Density	43264 pixels/m ²	
Pixels Per module	52*52 Dots	
Module Size	W250mmxH250mm	
Pixels Per Panel	104*208 Dots	104*156 Dots
Panel Size	W500mmxH1000mmxD78mm	W500mmxH750mmxD78mm
Weight	34kg/m ²	37kg/m ²
Maintenance	100% Front and 100% Rear	
Ingress Protection	IP69K (IP66 included)	
Aspect Ratio	1:2	2:3
Panel Area	0.5 m ²	0.375 m ²
Planeness	≤0.2mm	
Recommended Viewing Distance	≥5m	
Environment	Outdoor	
Material	Die-casting Aluminum	
Calibration	Support brightness and chroma	
Brightness Control	Manual/Automatic	
Color Temperature	2000-9500K Adjustable	
Horizontal Viewing Angle	160°	
Vertical Viewing Angle	140°	
Contrast Ratio	6000:1	
Input Power <Max>	650W/ m ²	
Input Power <Typical>	217W/ m ²	
Input Voltage	100~240VAC	
Processing Depth	14bit	
Refresh Rate	7680 Hz	
Video Frame Rate	50/60 Hz	
Input Power Frequency	50~60 Hz	
LED Life Time	100,000 Hours	
Operating Temperature/Humidity	-20°C~+60°C (Optional - 40°C)/10~90%RH	
Storage Temperature/Humidity	-30°C~+60°C (Optional - 40°C)/10~80%RH	
Standard Mounting Configuration	Fixed	

Note: Specifications are for reference only and are subject to change without notice.

Power consumption tolerance: ±15%, according to the actual situation.