

URMⅢ3

500mm×500mm Indoor

Die-cast Aluminum LED Display Unit



Product features:

1. Click-lock—true single-person installation.
2. Flip-shield— comprehensive corner protection.

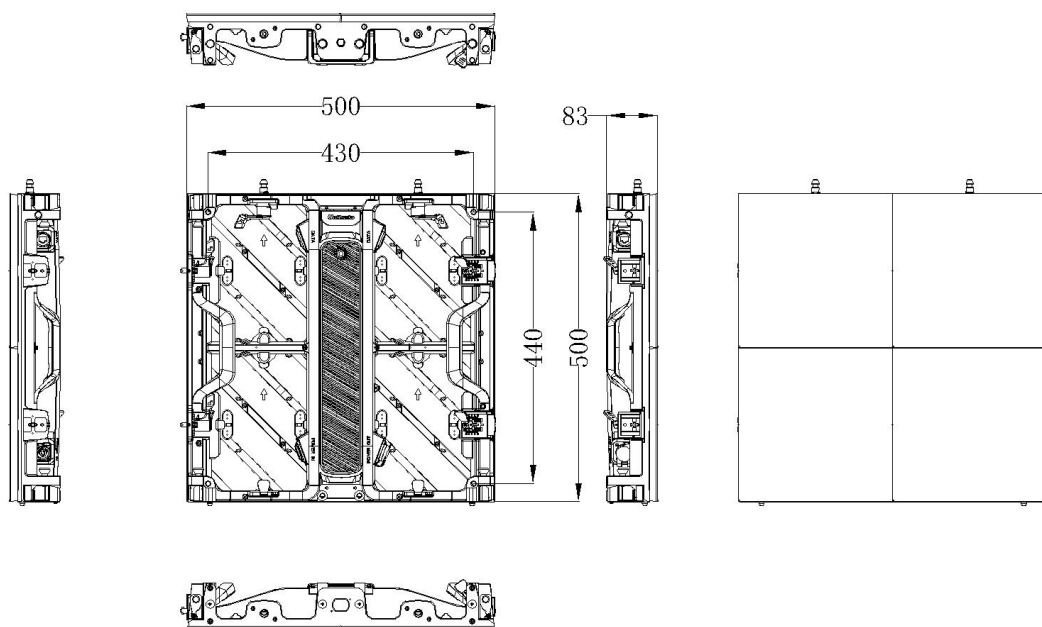

Main Technical Specifications:

Parameter	Value
Pixel Pitch	3.9mm
LED Type	3-in-1 Black SMD
Brightness	800 cd/m ²
Pixel Density	65,536 pixels/m ²
Pixels Per Panel	128×128 pixels
Module Size	W250mm×H250mm
Panel Size	W500mm×H500mm×D83mm
Weight	8 kg/panel
Maintenance	Rear
Ingress Protection	IP30
Curve	(Convex) -10°~+10°(Concave)
Aspect Ratio	1:1
Panel Area	0.25 m ²
Recommended Viewing Distance	≥3.9m
Environment	Indoor
Material	Die-cast Aluminum
Calibration	Support Brightness and Chroma
Brightness Control	Manual/Automatic
Color Temperature	2,000K-9,300K Adjustable
Horizontal Viewing Angle	160°
Vertical Viewing Angle	160°
Contrast Ratio	3,000:1
Input Power <Max>	124 W/panel
Input Power <Typical>	36 W/panel
Input Voltage	100~240 VAC
Processing Depth	14 bit
Scan Method	1/16
Refresh Rate	3840@60 Hz
Video Frame Rate	50/60 Hz
Input Power Frequency	50~60 Hz
LED Life Time	100,000 Hours
Operating Temperature/Humidity	-10℃~+45℃/10~80%RH
Storage Temperature/Humidity	-20℃~+50℃/10~80%RH
Standard Mounting Configuration	Hanging, Stacking
Certification	TUV-CE/CB/FCC/IC/UL
Certification model	URM3 500X500 V3R2

- Note:
1. Specifications are for reference based on normal temperature conditions(25℃).
 2. Power consumption tolerance: ±15%, according to the installation site environment.
 3. The deviation of cabinet weight is about ±5% duo to different measurements.
 4. Specifications are for reference only and are subject to change without notice.